

070041 軟部の悪性腫瘍（脊髄を除く。）

手術・処置等2
 1：人工呼吸、中心静脈注射
 2：放射線療法
 3：化学療法ありかつ放射線療法なし

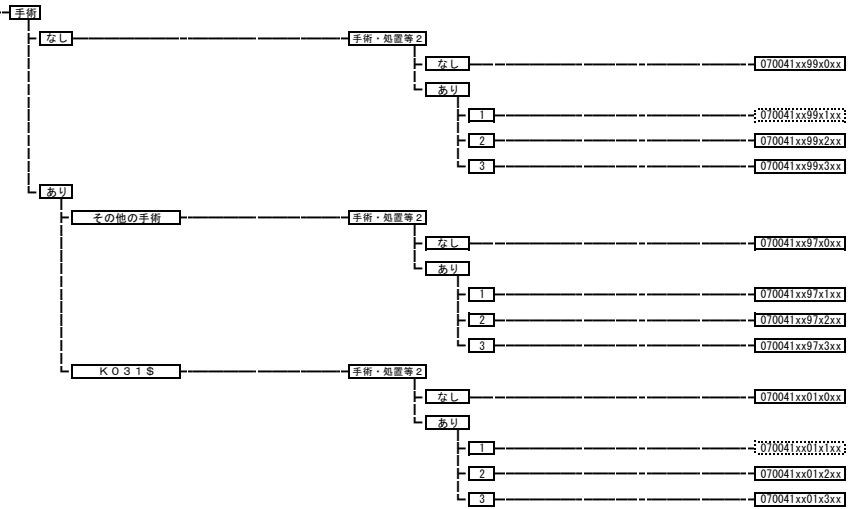

070050 肩関節炎、肩の障害（その他）

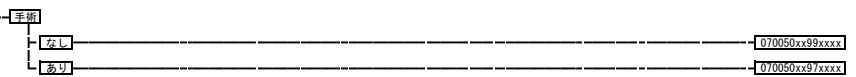

070060 手肘の関節炎

070060xxxxxxx

070070 骨髓炎（上肢）

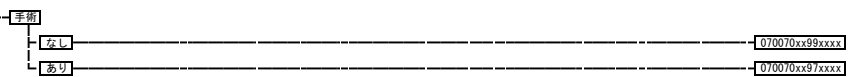

070071 骨髓炎（上肢以外）

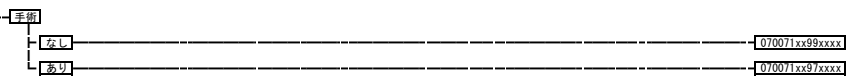

070080 滑膜炎、腱鞘炎、軟骨などの炎症（上肢）

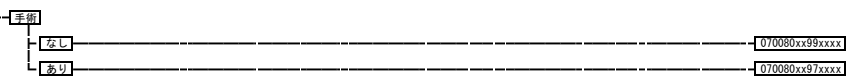

070085 滑膜炎、腱鞘炎、軟骨などの炎症（上肢以外）

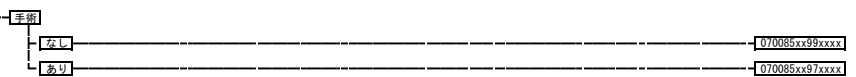

070090 筋炎（感染性を含む。）

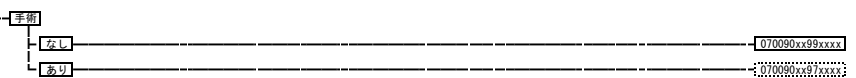

| | | |
|---------------|------------|---|
| 07010x | 化膿性関節炎（下肢） | 070101 化膿性・結核性股関節炎 070102 化膿性膝関節炎 070103 下肢（股関節以外）関節炎 |
|---------------|------------|---|

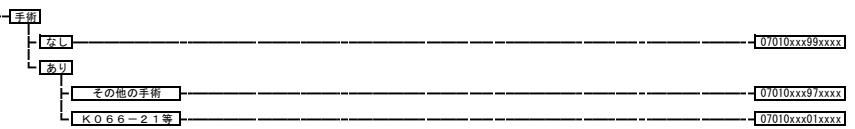

| | |
|---------------|---------------------|
| 070150 | 上肢神経障害（胸郭出口症候群を含む。） |
|---------------|---------------------|

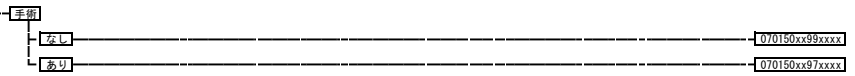

| | |
|---------------|----------|
| 070160 | 上肢末梢神経麻痺 |
|---------------|----------|

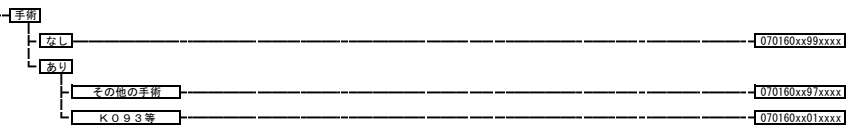

| | |
|---------------|--------|
| 070170 | 下肢神経疾患 |
|---------------|--------|

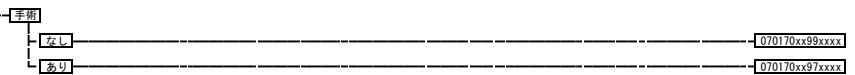

| | |
|---------------|------|
| 070180 | 脊椎変形 |
|---------------|------|

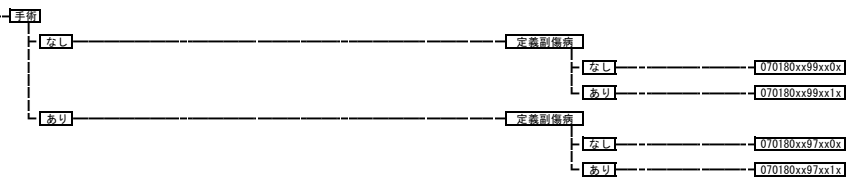

| | |
|---------------|------------------|
| 070190 | 上肢・手の変形（偽関節を除く。） |
|---------------|------------------|

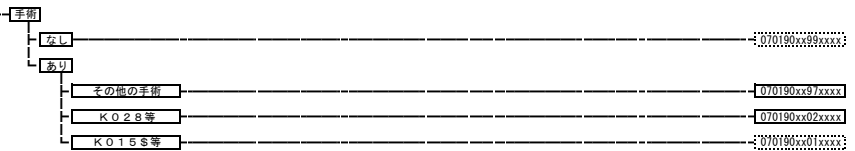

| | |
|---------------|---------------|
| 070200 | 手関節症（変形性を含む。） |
|---------------|---------------|

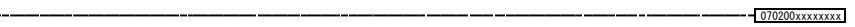

| | |
|---------------|-------|
| 070210 | 下肢の変形 |
|---------------|-------|

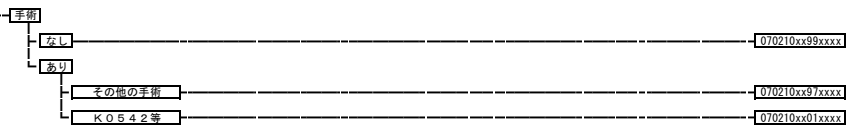

| | |
|---------------|---------------|
| 070230 | 膝関節症（変形性を含む。） |
|---------------|---------------|

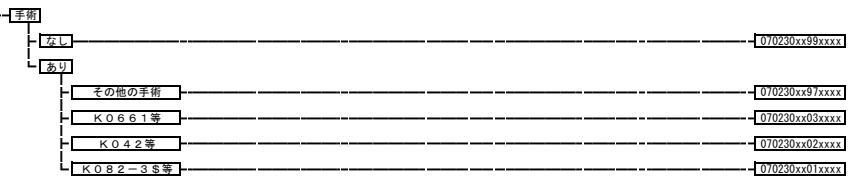

| | |
|---------------|-------|
| 070240 | 動揺関節症 |
|---------------|-------|

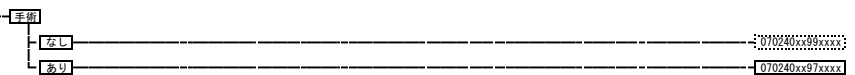

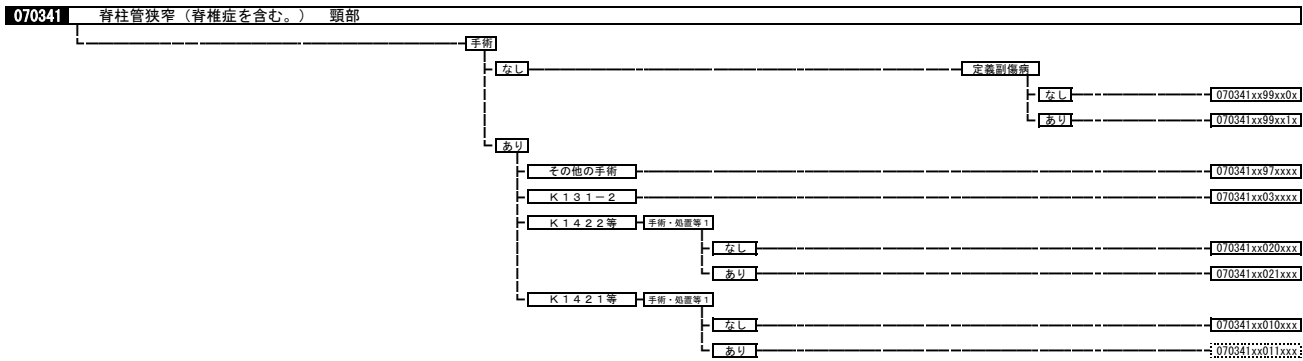
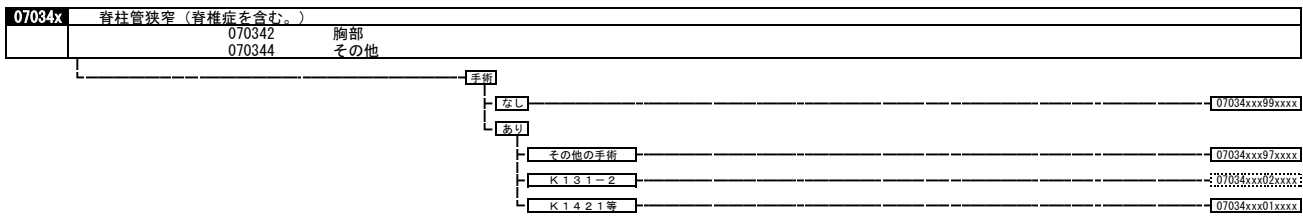
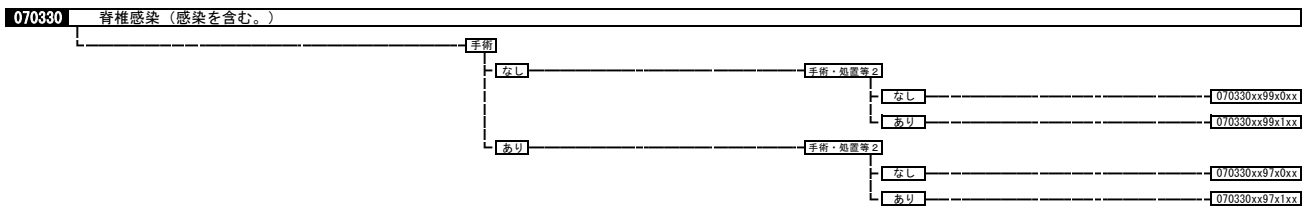
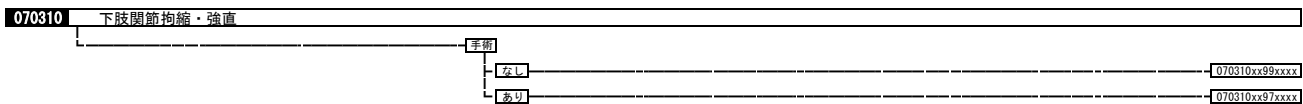
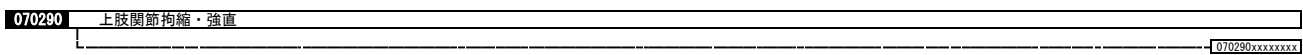
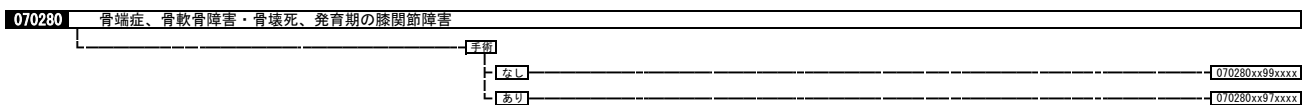
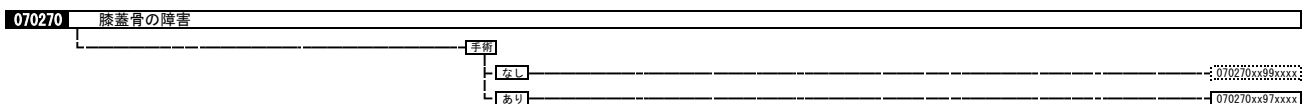
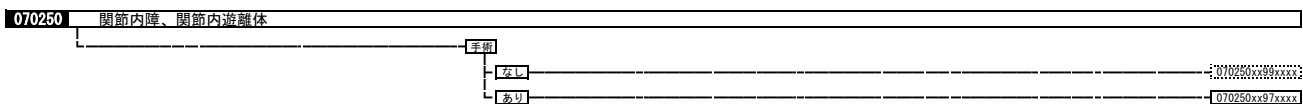

070343 脊柱管狭窄（脊髄症を含む。） 腰部骨盤、不安定椎

手術・処置等 2
 1: 脳神経造影剤使用撮影加算
 2: 神経ブロック（局所麻酔剤又はボツリヌス毒素使用）
 仙骨部硬膜外ブロックなど

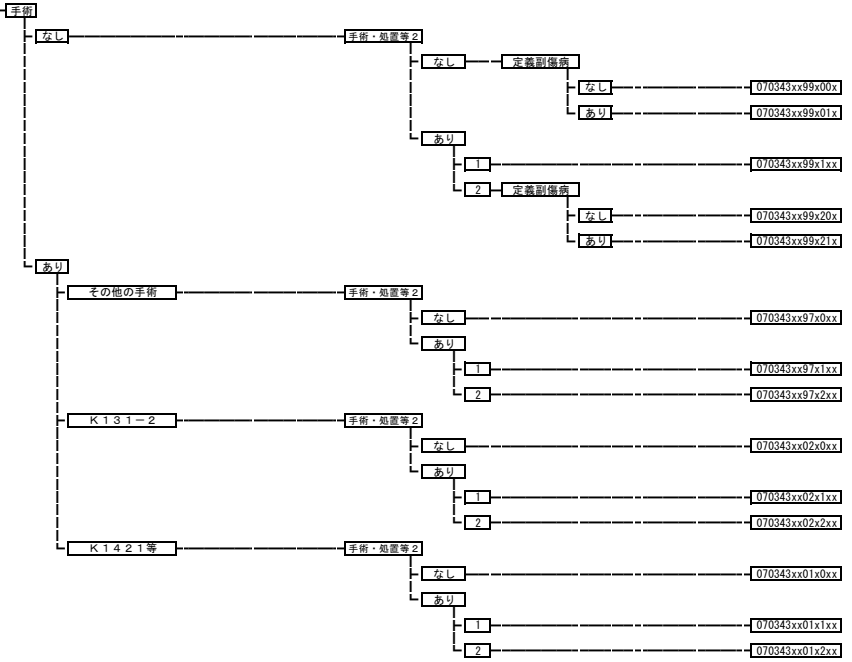

070350 椎間板変性、ヘルニア

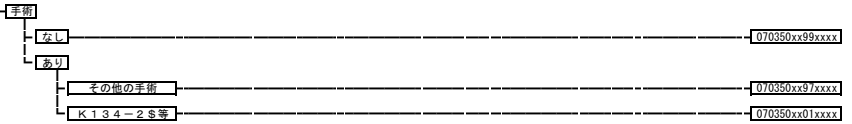

070370 脊椎骨粗鬆症

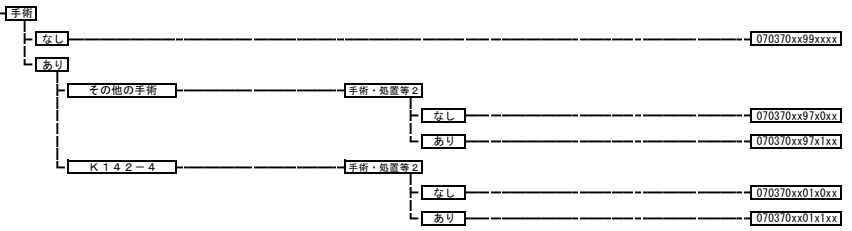

070380 ガングリオン

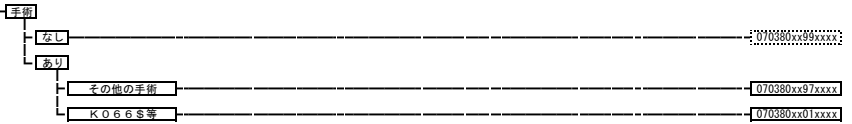

070390 線維芽細胞性腫瘍

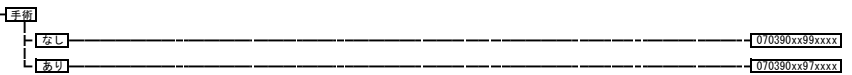

070395 壊死性筋膜炎

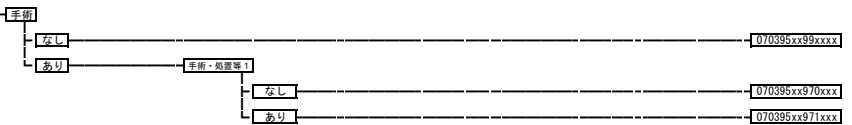

| | |
|---------------|-----------------------|
| 07040x | 股関節骨頭壊死、股関節症（変形性を含む。） |
| | 070401 股関節骨頭壊死 |
| | 070402 股関節症（変形性を含む。） |

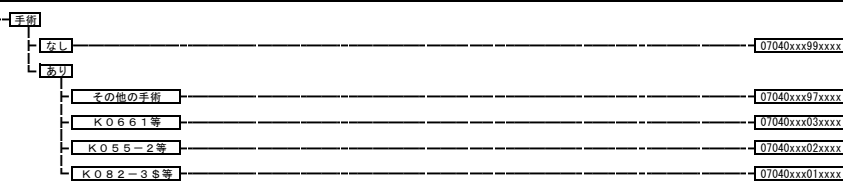

| | |
|---------------|----------|
| 070420 | 大腿骨頭すべり症 |
|---------------|----------|

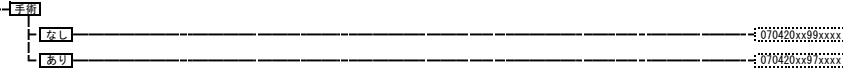

| | |
|---------------|-----------------------|
| 070430 | 神経栄養養症、骨成長障害、骨障害（その他） |
|---------------|-----------------------|

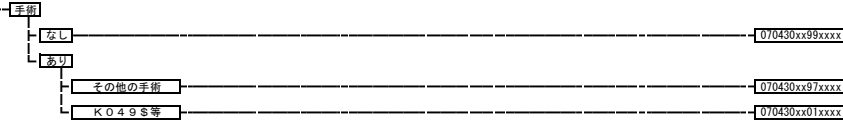

| | |
|---------------|-------------|
| 070440 | 色素性絨毛結節性滑膜炎 |
|---------------|-------------|

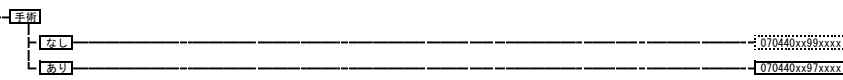

| | |
|---------------|----------|
| 070460 | 股関節ベルテス病 |
|---------------|----------|

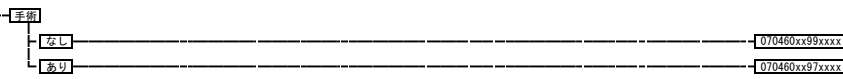

| | |
|---------------|--------|
| 070470 | 関節リウマチ |
|---------------|--------|

- 手術・処置等2
 1: 人工呼吸など
 2: リハビリテーション
 3: エタネルセプト
 4: トファシチニブクエン酸塩など
 5: アバタセプト、トシリズマブ
 6: インフリキシマブ
 7: インフリキシマブ（強直性脊椎炎の場合）

